



# MASTERCcolour CDM-TC Elite 70W/930 G8.5 ICT

## Product family description

Single-ended, compact size, high-efficiency Ceramic Metal Halide discharge lamp

## Product Features

- Crisp white light
- Excellent colour rendering (Ra 90)
- Reliable lifetime performance
- Stable colour performance during lifetime
- Increased light output compared with regular MASTERCcolour lamps
- Improved maintenance compared with regular MASTERCcolour lamps
- Burning position for

## Product Benefits

- Outstanding rendering of displayed merchandise due to high colour rendering (Ra 90) in combination with high lumen output; best offer in the market for 'enhancing merchandize'
- Excellent colour quality remains stable over lifetime
- Light output over lifetime maintains display brightness
- High efficacy and long lifetime for lowest operating costs and low heat generation
- Relatively low heat generation enhances comfort for shoppers and staff
- UV Block for reduced fading risk of merchandise
- Allows design of very compact luminaires with high beam intensities

## Environment

- Good environmental choice because of high energy efficiency and long reliable life
- This product is a Philips Green Flagship
- This product is RoHS compliant
- This product is covered by WEEE

## Application

**PHILIPS**

- Accent and display lighting with a sparkling effect, excellent solution for Retail
- General and decorative lighting

### Luminaires

- Must be used in closed luminaires with a proper cover (IEC 61167 and IEC 60958)

### System

- Must be used with electronic gear such as Philips PrimaVision

Product data	
Order code	208194 15
Full product code	871150020819415
loccod	
Full product name	MASTERCcolour CDM-TC Elite 70W/930 G8.5 ICT
Order product name	MASTERC CDM-TC Elite 70W/930 G8.5 ICT/I2
Packing type	1 Lamp in a Folding Carton
Pieces per pack	1
Packing configuration	I2
Packs per outerbox	I2
Bar code on pack - EAN1	8711500208194
Bar code on intermediate packing - EAN2	
Bar code on outerbox - EAN3	8711500208200
Logistic code(s) - I2NC	9280 923 05131
ILCOS code	MT-70/30/1B-H-G8.5
Net weight per piece	0.010 KG
Successor order code	
Cap-Base	G8.5
Bulb	T14 [T 14 mm]
Bulb Material	UV-Block Quartz
Bulb Finish	Clear
Burning Position	any [Any/Universal]
Life to 5% failures	- hr
Life to 10% failures	- hr
Life to 20% failures	- hr
Life to 50% failures	- hr
Life to 50% failures EM	- hr
Life to 50% failures EL	12000 hr
Life to 10% failures EM	- hr
Life to 5% failures EL	7000 hr
Life to 5% failures EM	- hr
Life to 20% failures EL	10000 hr
Life to 20% failures EM	- hr
Life to 10% failures EL	9000 hr
Lamp Wattage	70W
Lamp Wattage EM	- W
Lamp Wattage EL	73 W
Lamp Voltage	87 V
Lamp Current EM	- A
Lamp Current EL	0.840 A
Dimmable	no
Mercury (Hg) Content	8.5 mg
Colour Code	930 [CCT of 3000K]



Product data	
Colour Rendering Index	90 Ra8
Colour Designation	Warm white
Colour Temperature	3000 K
Chromaticity Coordinate X	438 -
Chromaticity Coordinate Y	395 -
Lamp Luminous Flux EM	- Lm
Lamp Luminous Flux EL	7300 Lm
Lamp Luminous Efficacy EM	- Lm/W
Lamp Luminous Efficacy EL	97 Lm/W
Lumen Maintenance 2000h	- %
Lumen Maintenance EM 2000h	- %
Lumen Maintenance EL 2000h	95 %
Lumen Maintenance 5000h	- %
Lumen Maintenance EM 5000h	- %
Lumen Maintenance EL 5000h	88 %
Lumen Maintenance 10000h	- %
Lumen Maintenance EM 10000h	- %
Lumen Maintenance EL 10000h	80 %
Lumen Maintenance 12000h	- %
Bulb Temperature	550 C



**MASTERC CDM-TC Elite 70W/930**

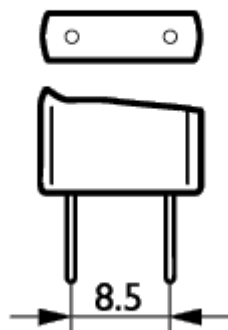
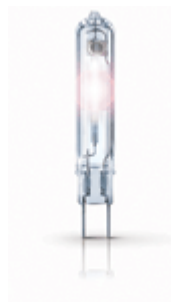

**Cap-Base G8.5**

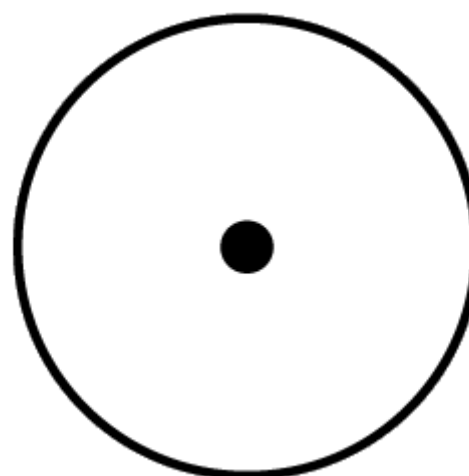

**Burning Position any**

**PHILIPS**

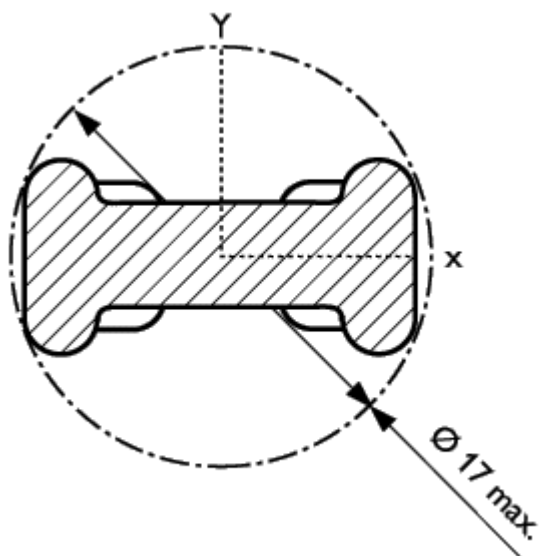

MASTERC CDM-TC Elite

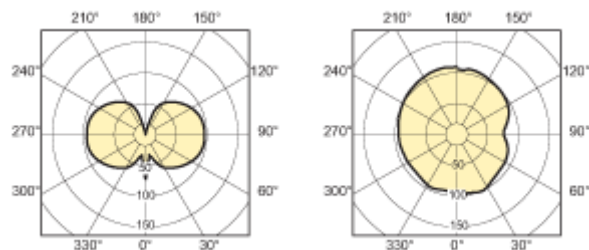

MASTERC CDM-TC Elite 70W/930

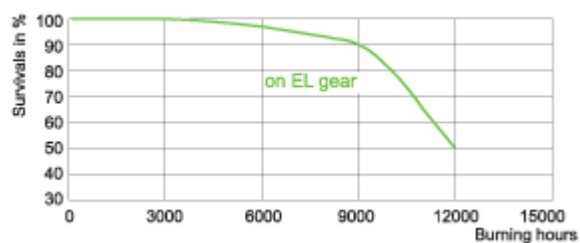

on electronic gear

MASTERC CDM-TC Elite 70W/930

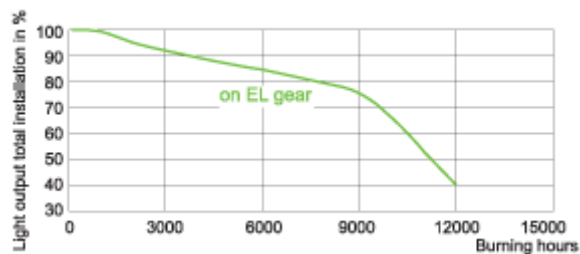

on electronic gear

MASTERC CDM-TC Elite 70W/930



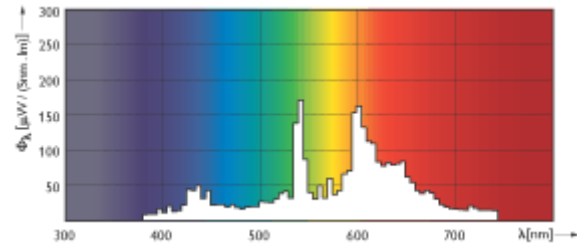
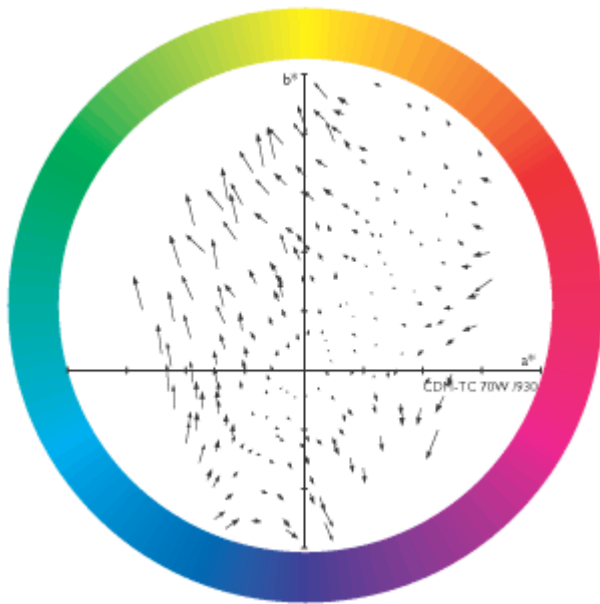

MASTERCour CDM-TC Elite 70W /930

MASTERC CDM-TC Elite 70W/930

MASTERC CDM-TC Elite 70W/930

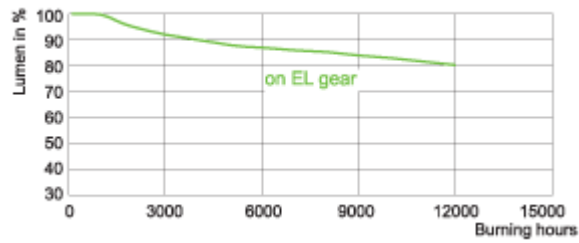

on electronic gear

MASTERC CDM-TC Elite 70W/930

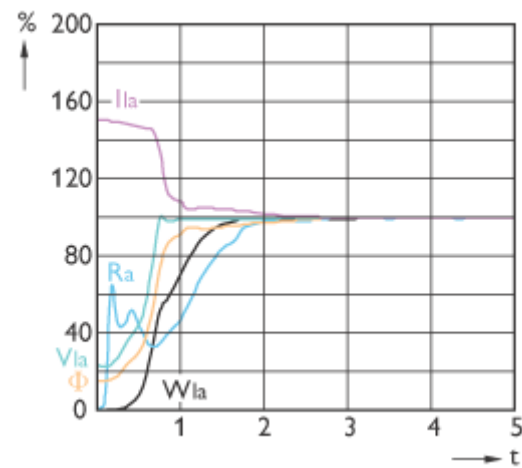

MASTERC CDM-TC Elite 70W/930

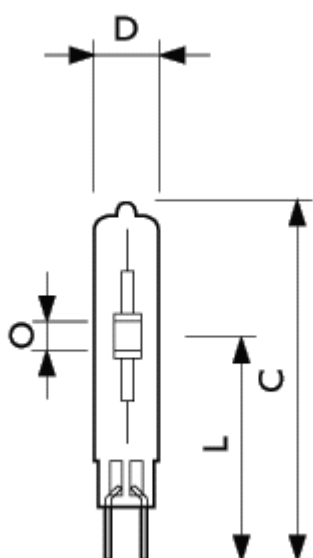

**MASTERC CDM-TC Elite 35W/70W**

	C	C	D	D	L	L
Full product name	Max	Max	Max	Max	Min	Min
MASTERCour CDM-TC Elite 70W/930 G8.5 ICT	85	85	14.35	14.35	51	51

	L	L	L	L	O	O
Full product name	Nom	Nom	Max	Max	Min	Min
MASTERCour CDM-TC Elite 70W/930 G8.5 ICT	52	52	53	53	-	-

	0	0	0	0
Full product name	Nom	Nom	Max	Max
MASTERC olour CDM-TC Elite 70W/ 930 G8.5 ICT	6	6	-	-



©2009 Koninklijke Philips Electronics N.V.

All rights reserved. Reproduction in whole or in part is prohibited without the prior written consent of the copyright owner. The information presented in this document does not form part of any quotation or contract, is believed to be accurate and reliable and may be changed without notice. No liability will be accepted by the publisher for any consequence of its use. Publication thereof does not convey nor imply any license under patent- or other industrial or intellectual property rights.

Document order number : 0000 000 00000